



inyuanpower

inyuanpower

电源适配器&充电器

PROFESSIONAL POWER ADAPTER
AND CHARGER

深圳市盈源电子有限公司

Shenzhen Shi Yingyuan Electronics Co.,Ltd

盈源电源(惠州)有限公司

Yingyuan Power Supply (Huizhou) Co.,Ltd

澳莱特新能源(惠州)有限公司

Alright Power New Energy (Huizhou) Co.,Ltd

公司地址:深圳市宝安区黄麻布社区勒竹角村鸿业工业园8栋7楼

Company address: 7th Floor, Building 8, Hongye Industrial Park, Lezhujiao Village,
Huangmabu Community, Bao'an District, Shenzhen

工厂地址:惠州市惠阳区镇隆镇甘陂村盈源科创园3栋

Factory address: Building 3, Yingyuan Science and Innovation Park, Ganbei Village,
Zhenlong Town, Huiyang District, Huizhou City

GuangDongChina PC.:516200

www.szyingyuan.com

深圳市盈源电子有限公司

Shenzhen Shi Yingyuan Electronics Co.,Ltd

发展历程

DEVELOPMENT HISTORY





关于我们

深耕行业20余载
致力于开关电源
充电器研发制造

荣获国家高新技术企业 专精特新企业

总公司深圳市盈源电子有限公司于2006年9月在深圳宝安创立经过20载的耕耘,已发展成卓越的电源品牌,获得了国家高新技术企业及专精特新企业认定。

- 盈源电源(惠州)有限公司(主营中小功率开关电源设计及制造)
- 澳莱特新能源(惠州)有限公司(主营大功率开关电源及电池充电器设计及制造)
- 赢硕科技(惠州)有限公司(主营变压器制造)

Shenzhen Yingyuan Electronics Co., Ltd as the parent company was founded in September 2006 in Baoan Shenzhen. Ater 16 years development and accumulation,we have achieved leading positions of power supply in international market with the recognition of "High-Tech Enterprise" and "Specialized and Unique New Products Enterprise".

- Inyuan power supply (huizhou) Co.,Ltd (specialized in produce &R&D medium-small power switch power supply
- Alrightpower new energy(huizhou) co.,ltd (specialized in high-power switch power supply and R&D of battery charger)
- Inshuo Technology (specialized in transformer manufacture)

合作客户 | CUSTOMER



公司成立
2006年



厂房面积
60000m²



员工
1100+



月产能
300万+套

盈源电源&澳莱特新能源专注开关电源, 充电器的研发生产, 工厂无尘车间面积30000m², 员工总数约1100人, 月产能达300万套以上, 年营业额超5亿RMB。公司通过了ISO9001, ISO14001, ISO13485等管理体系认证, 产品符合并通过各进口国安规。

技术是公司第一生产力, 公司100多名研发技术人员让我们始终在技术上走在行业前沿, 经过他们努力公司取得了多个实用创新及发明专利。

Sinyuan power supply & Alrightpower New Energy is engaged in the R&D and manufacture of switch power supply and battery charger with more than 900 manpower,certified by Quality system certification like ISO9000,ISO14001,ISO13485.etc. The Dust-free workshop covers an area of 30000M2, the production capacity monthly can reach 300Millions sets , annual turnover over 500 million RMB.

Technology is the No.1 productivity in Inyuan & Alrightpower. We are always at forefront of technology by the strong technology support by more than 100 R&D technicians . With staff's hardworking and professional experience, we have obtained a lot of Practical Innovation and Invention Patent.



公司环境 ENVIRONMENT

荣誉资质 QUALIFICATIONS HONORS



C24

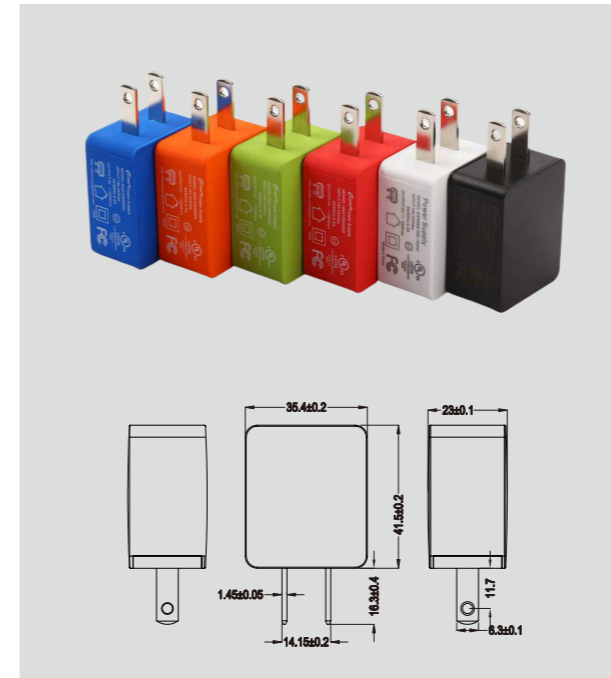

产品参数 / SPECIFICATIONS

输入电压 Input Voltage:100-240V
 输入频率 Input Frequency:50/60Hz
 输入电流 Input Current:0.5A Max
 输出电压 Out Voltage:5V
 输出电流 Output Current:1000-2000mA
 能效等级 Energy Class:VI
 工作温度 Operating Temperature:0-40°C
 储存温度 Storage Temperature:-20~80°C
 安规标准 Certification Standards:62368/CCC
 尺寸 Dimension:41.5*35.4*23MM
 重量 Weight:37g 质保 Warranty:2 years



C26

产品参数 / SPECIFICATIONS

典型输出 Typical Output:5V 9V 12V
 QC:5V3A/9V2A/12V1.5A:Max:18W
 额定输入电压 Rated Input Voltage:100-240V
 输入频率 Input Frequency:50/60Hz
 输入电流 Input Current:0.5A Max
 能效等级 Energy Class:VI
 工作温度 Operating Temperature:0-40°C
 储存温度 Storage Temperature:-20~80°C
 安规标准 Certification Standards:62368/CCC
 尺寸 Dimension:43*39*21.9MM
 重量 Weight:60g 质保 Warranty:2 years

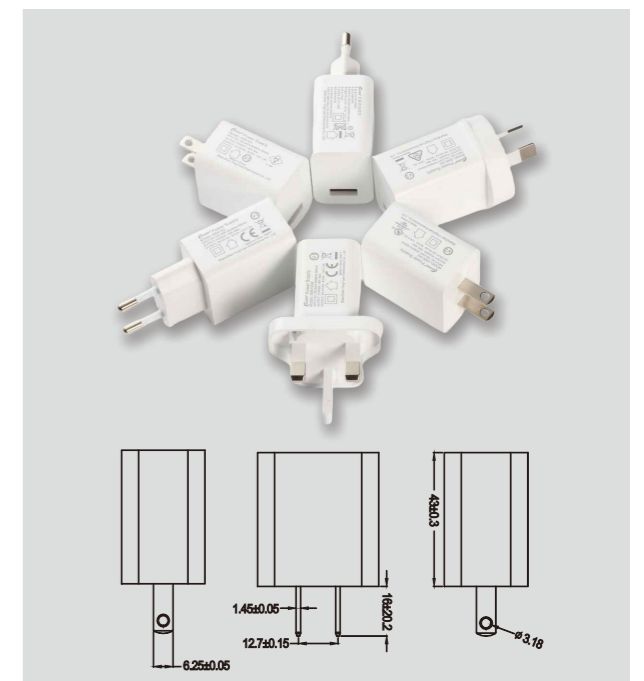

3C数码 PD充电器系列 CHARGER SERIES



20WPD-C1902



产品参数 / SPECIFICATIONS

典型输出 Typical Output:5V 9V 12V
 PD:5V3A/9V2.22A/12V1.67A:Max:20W
 额定输入电压 Rated Input Voltag:100-240V
 输入频率 Input Frequency:50/60Hz
 输入电流 Input Current:0.5A Max
 能效等级 Energy Class:VI
 工作温度 Operating Temperature:0-40°C
 储存温度 Storage Temperature:-20~80°C
 安规标准 Certification Standards:62368/CCC
 尺寸 Dimension:43*39*21.9MM
 重量 Weight:75g 质保 Warranty:2 years



30WPD GAN-C2408



产品参数 / SPECIFICATIONS

典型输出 Typical Output:5V 9V 12V 15V 20V
 PD:5V3A/9V3A/12V2.5A /15V2A/20V1.5A:Max:30W
 PPS: 3.3-10Vdc, 3.0A:Max: 30W,
 PPS: 3.3-15Vdc, 2.0A:Max: 30W
 额定输入电压 Rated Input Voltag:100-240V
 输入频率 Input Frequency:50/60Hz
 输入电流 Input Current:0.8A Max
 能效等级 Energy Class:VI
 工作温度 Operating Temperature:0-40°C
 储存温度 Storage Temperature:-20~80°C
 安规标准 Certification Standards:62368 /CCC
 尺寸 Dimension:43*39*21.9MM
 重量 Weight:85g 质保 Warranty:2 years



20WPD-C2101

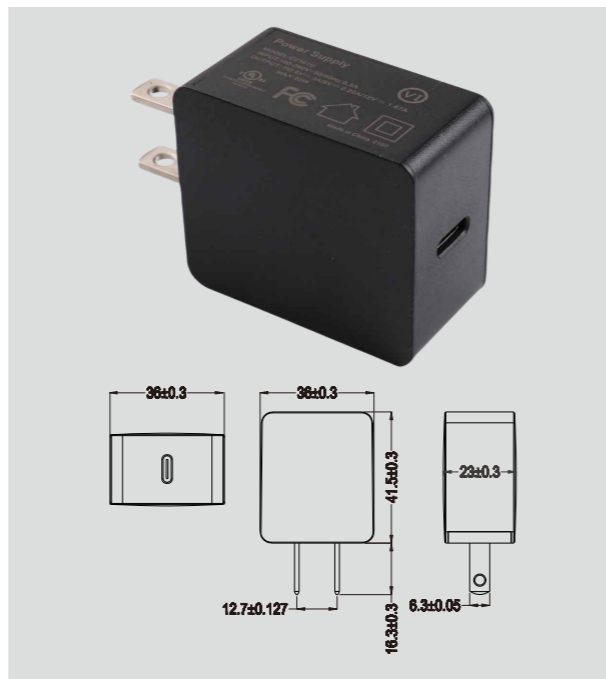

产品参数 / SPECIFICATIONS

典型输出 Typical Output:5V 9V 12V
 PD:5V3A/9V2.22A/12V1.67A:Max:20W
 额定输入电压 Rated Input Voltag:100-240V
 输入频率 Input Frequency:50/60Hz
 输入电流 Input Current:0.5A Max
 能效等级 Energy Class:VI
 工作温度 Operating Temperature:0-40°C
 储存温度 Storage Temperature:-20~80°C
 安规标准 Certification Standards:62368
 尺寸 Dimension:41.5*36*23MM
 重量 Weight:40g 质保 Warranty:2 years



产品参数 / SPECIFICATIONS

典型输出 Typical Output:5V 9V 12V 15V 20V
 PD:5V3A/9V3A/12V2.5A /15V2A/20V1.5A:Max:30W
 额定输入电压 Rated Input Voltag:00-240V
 输入频率 Input Frequency:50/60Hz
 输入电流 Input Current:0.8A Max
 能效等级 Energy Class:VI
 工作温度 Operating Temperature:0-40°C
 储存温度 Storage Temperature:-20~80°C
 安规标准 Certification Standards:62368/CCC
 尺寸 Dimension:53*53*28MM
 重量 Weight:350g 质保 Warranty:2 years



30WPD-C2304

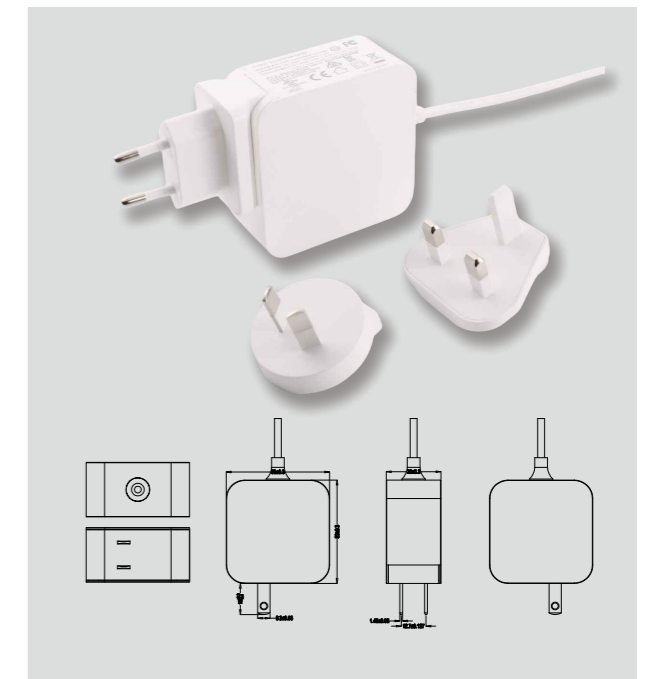

45WPD-C2303

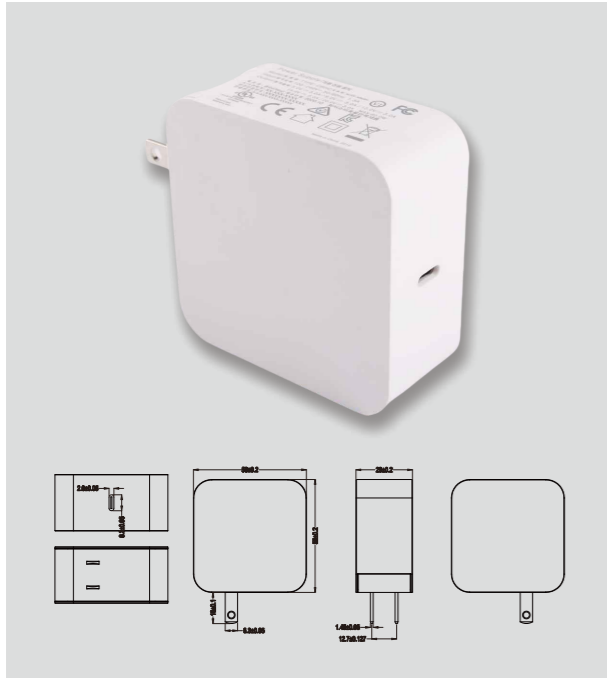

产品参数 / SPECIFICATIONS

典型输出 Typical Output:5V 9V 12V 15V 20V
 PD:5V3A/9V3A/12V3A /15V3A/20V2.25A:Max:45W
 额定输入电压 Rated Input Voltag:100-240V
 输入频率 Input Frequency:50/60Hz
 输入电流 Input Current:1.3A Max
 能效等级 Energy Class:VI
 工作温度 Operating Temperature:0-40°C
 储存温度 Storage Temperature:-20~80°C
 安规标准 Certification Standards:62368/CCC
 尺寸 Dimension:58*58*29MM
 重量 Weight:118g 质保 Warrenty:2 years



100WPD GAN-C2307

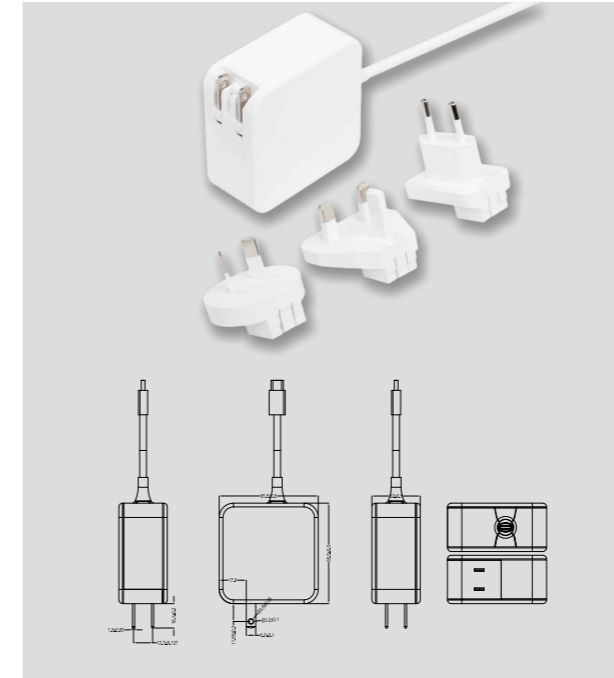

产品参数 / SPECIFICATIONS

典型输出 Typical Output:5V 9V 12V 15V 20V
 PD:5V3A/9V3A/12V2.5A /15V2A/20V5A:Max:100W
 PPS: 3.6V-20.0Vdc, 5.0A:Max:100W
 额定输入电压 Rated Input Voltag:100-240V
 输入频率 Input Frequency:50/60Hz
 输入电流 Input Current:2A Max
 能效等级 Energy Class:VI
 工作温度 Operating Temperature:0-40°C
 储存温度 Storage Temperature:-20~80°C
 安规标准 Certification Standards:62368/CCC
 尺寸 Dimension:66.5*65.5*32MM
 重量 Weight:170g 质保 Warrenty:2 years



65WPD-C2305

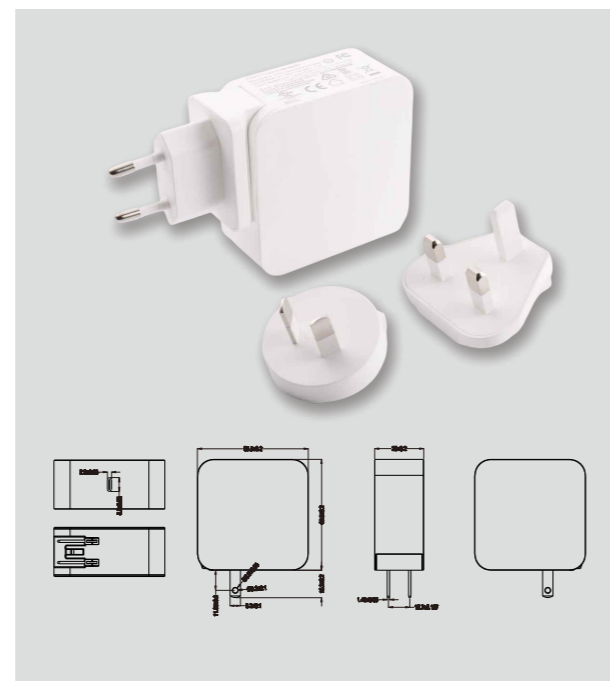

产品参数 / SPECIFICATIONS

典型输出 Typical Output:5V 9V 12V 15V 20V
 PD:5V3A/9V3A/12V3A /15V3A/20V3.25A:Max:65W
 额定输入电压 Rated Input Voltag:100-240V
 输入频率 Input Frequency:50/60Hz
 输入电流 Input Current:1.5A Max
 能效等级 Energy Class:VI
 工作温度 Operating Temperature:0-40°C
 储存温度 Storage Temperature:-20~80°C
 安规标准 Certification Standards:62368/CCC
 尺寸 Dimension:65*65*29MM
 重量 Weight:150g 质保 Warrenty:2 years



产品参数 / SPECIFICATIONS

典型输出 Typical Output:5V 9V 12V 15V 20V
 PD:5V3A/9V3A/12V2.5A /15V2A/20V5A:Max:100W
 PPS: 3.6V-20.0Vdc, 5.0A:Max:100W
 额定输入电压 Rated Input Voltag:100-240V
 输入频率 Input Frequency:50/60Hz
 输入电流 Input Current:2A Max
 能效等级 Energy Class:VI
 工作温度 Operating Temperature:0-40°C
 储存温度 Storage Temperature:-20~80°C
 安规标准 Certification Standards:62368
 尺寸 Dimension:75*75*33MM
 重量 Weight:350g 质保 Warrenty:2 years



140WPD GAN-C2410

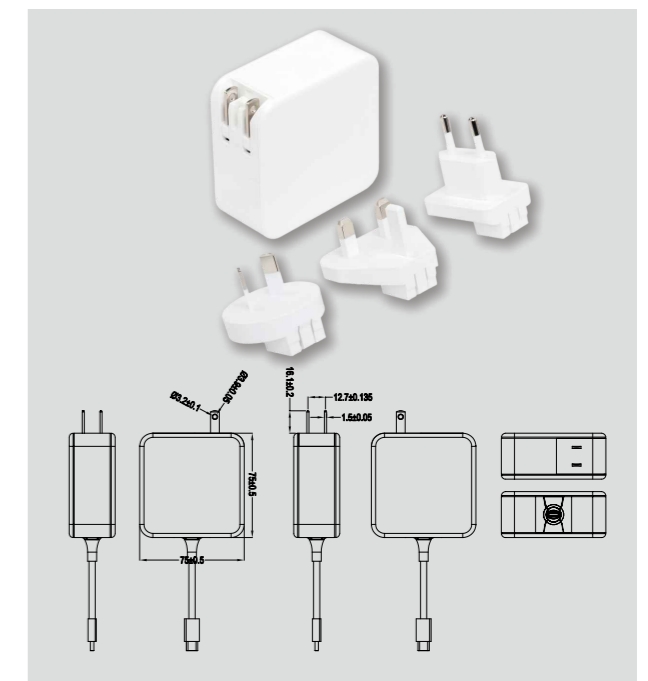



电动摩托车

ELECTRIC MOTORCYCLE

16320-6W

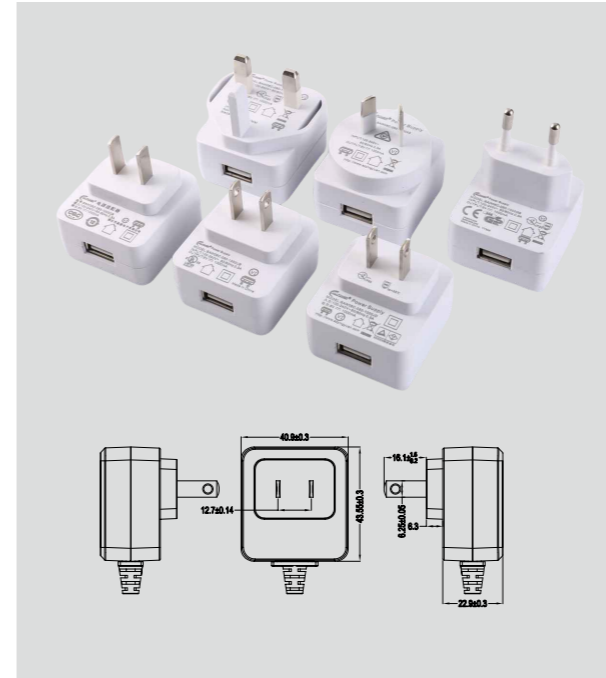

产品参数 / SPECIFICATIONS

输入电压 Input Voltage: 100-240V
 输入频率 Input Frequency: 50/60Hz
 输入电流 Input Current: 0.3A
 输出电压 Out Voltage: 5.0V-24.0V
 输出电流 Output Current: 10mA-1200mA
 能效等级 Energy Class: VI
 工作温度 Operating Temperature: 0-40°C
 储存温度 Storage Temperature: -20~80°C
 安规标准 Certification Standards: 62368/61558/UL1310 /CCC/CQC
 尺寸 Dimension: 43.55*40.9*22.9MM
 重量 Weight: 68g 质保 Warranty: 2 years



产品参数 / SPECIFICATIONS

典型输出 Typical Output: 5V 9V 12V
 PD: 5V3A/9V2.22A/12V1.67A; Max: 20W
 额定输入电压 Rated Input Voltage: 100-240V
 输入频率 Input Frequency: 50/60Hz
 输入电流 Input Current: 0.5A Max
 能效等级 Energy Class: VI
 工作温度 Operating Temperature: 0-40°C
 储存温度 Storage Temperature: -20~80°C
 安规标准 Certification Standards: 62368/CCC
 尺寸 Dimension: 43.55*40.9*22.9MM
 重量 Weight: 86g 质保 Warranty: 2 years



12W-17070

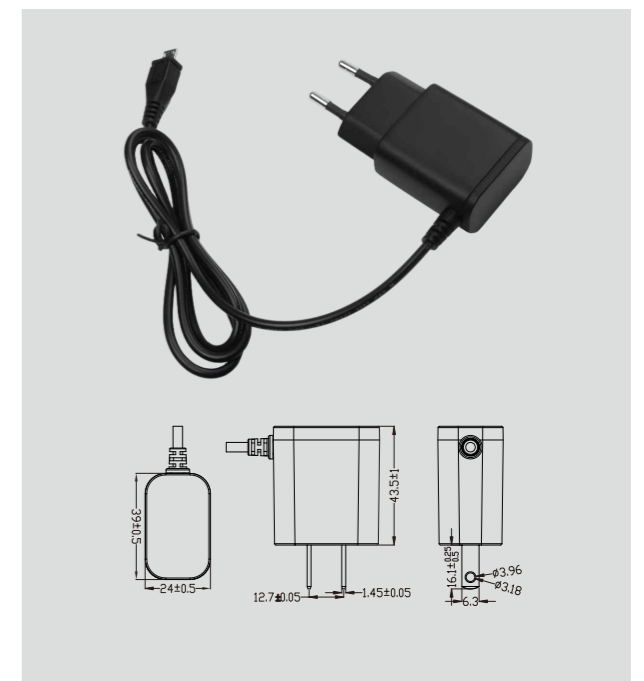

15W-19080

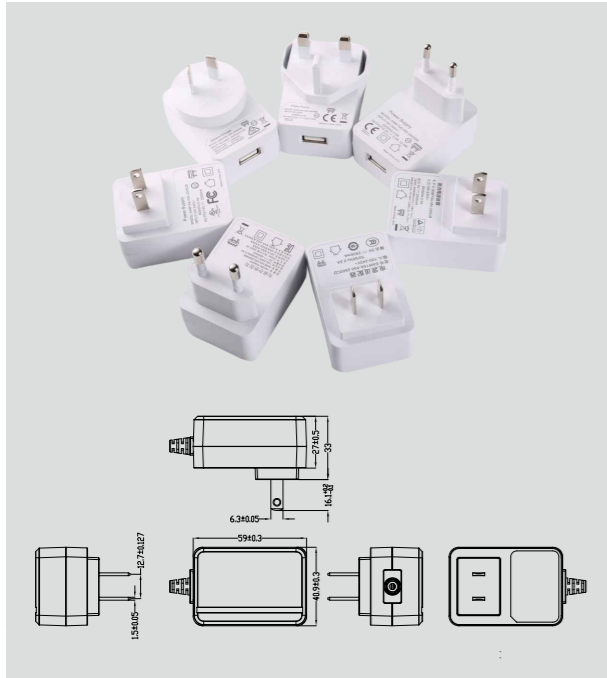

产品参数 / SPECIFICATIONS

输入电压 Input Voltage:100-240V
 输入频率 Input Frequency:50/60Hz
 输入电流 Input Current:0.5A
 输出电压 Out Voltage:5.0V-36.0V
 输出电流 Output Current:10mA-2500mA
 能效等级 Energy Class:VI
 工作温度 Operating Temperature:0-40°C
 储存温度 Storage Temperature:-20~80°C
 安规标准 Certification Standards:60335/62368/61558/
 UL1310/CCC/CQC
 尺寸 Dimension:59*40.9*27MM
 重量 Weight:85g 质保 Warranty:2 years



15W-24020

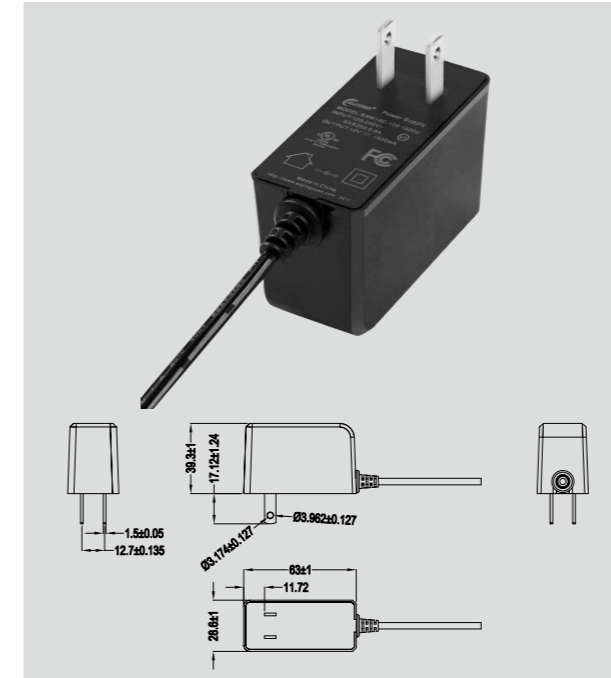

产品参数 / SPECIFICATIONS

输入电压 Input Voltage :100-240V
 输入频率 Input Frequency:50/60Hz
 输入电流 Input Current:0.5A or 0.3A max
 输出电压 Out Voltage:5.0V-36.0V
 输出电流 Output Current:100mA-2100mA
 能效等级 Energy Class:VI
 工作温度 Operating Temperature:0-40°C
 储存温度 Storage Temperature:-20~80°C
 安规标准 Certification Standards:62368/60335/ETL1310
 /CCC/CQC
 尺寸 Dimension:63*39.3*28.6MM
 重量 Weight:100g 质保 Warranty:2 years

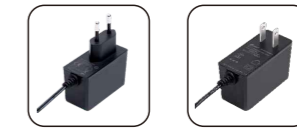

产品参数 / SPECIFICATIONS

输入电压 Input Voltage:100-240V
 输入频率 Input Frequency:50/60Hz
 输入电流 Input Current:0.5A
 输出电压 Out Voltage:5.0V-36.0V
 输出电流 Output Current:10mA-2500mA
 能效等级 Energy Class:VI
 工作温度 Operating Temperature:0-40°C
 储存温度 Storage Temperature:-20~80°C
 安规标准 Certification Standards:62368/61558/
 ETL1310/CCC/CQC
 尺寸 Dimension:56.5*40.2*28.5MM
 重量 Weight:82g 质保 Warranty:2 years

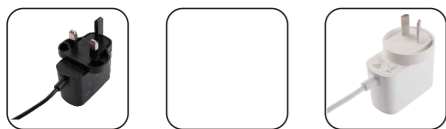

15W-20190

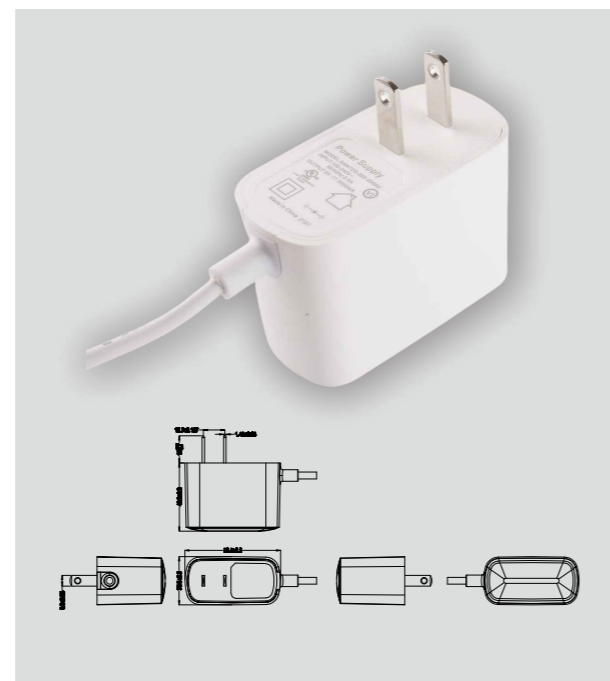

产品参数 / SPECIFICATIONS

输入电压 Input Voltage:100-240V
 输入频率 Input Frequency:50/60Hz
 输入电流 Input Current:0.6A
 输出电压 Out Voltage:5.0V-36.0V
 输出电流 Output Current:10mA-3000mA
 能效等级 Energy Class:VI
 工作温度 Operating Temperature:0-40°C
 储存温度 Storage Temperature:-20~80°C
 安规标准 Certification Standards:62368/61558/
 60335/UL1310//CCC/CQC
 尺寸 Dimension:59*40.9*26.4MM
 重量 Weight:90g 质保 Warranty:2 years



20W-18020

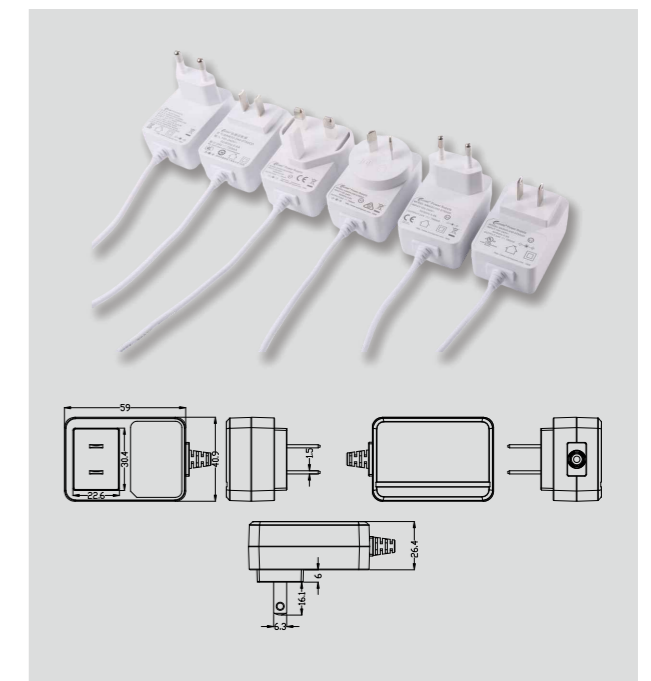

20W-24010

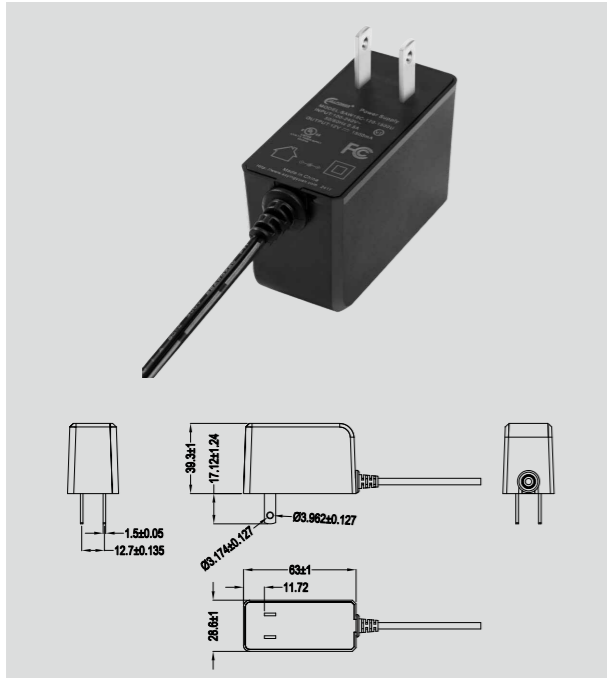

产品参数 / SPECIFICATIONS

输入电压 Input Voltage:100-240V
 输入频率 Input Frequency:50/60Hz
 输入电流 Input Current:0.6A
 输出电压 Out Voltage:5.0V-36.0V
 输出电流 Output Current:10mA-3000mA
 能效等级 Energy Class:VI
 工作温度 Operating Temperature:0-40°C
 储存温度 Storage Temperature:-20~80°C
 安规标准 Certification Standards:62368/60335/UL1310
 /CCC/CQC
 尺寸 Dimension:63*39.3*28.6MM
 重量 Weight:100g 质保 Warranty:2 years

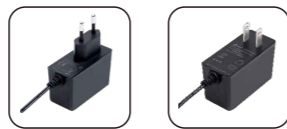

24W-25070

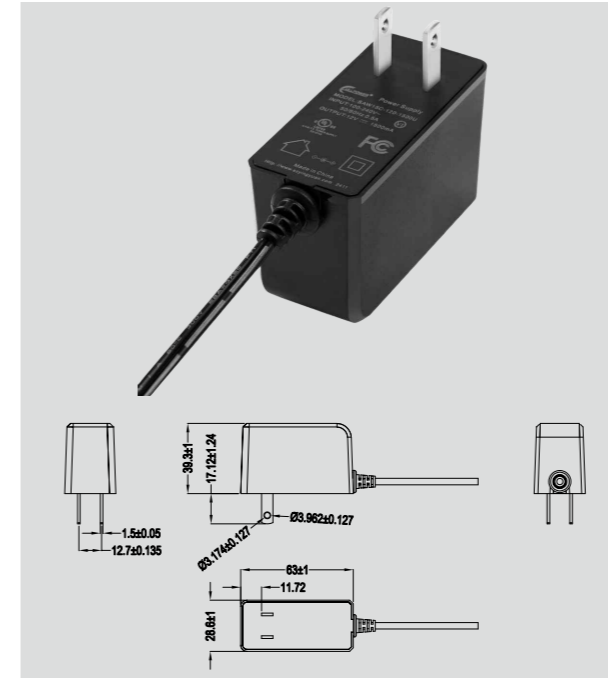

产品参数 / SPECIFICATIONS

输入电压 Input Voltage:100-240V
 输入频率 Input Frequency:50/60Hz
 输入电流 Input Current:0.8A
 输出电压 Out Voltage:5.0V-36.0V
 输出电流 Output Current:10mA-3000mA
 能效等级 Energy Class:VI
 工作温度 Operating Temperature:0-40°C
 储存温度 Storage Temperature:-20~80°C
 安规标准 Certification Standards:62368/61558/
 60335/ETL1310/CCC/CQC
 尺寸 Dimension:63*39.3*28.6MM
 重量 Weight:100g 质保 Warranty:2 years

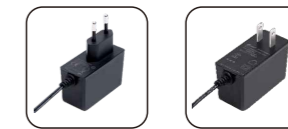

24W-22250

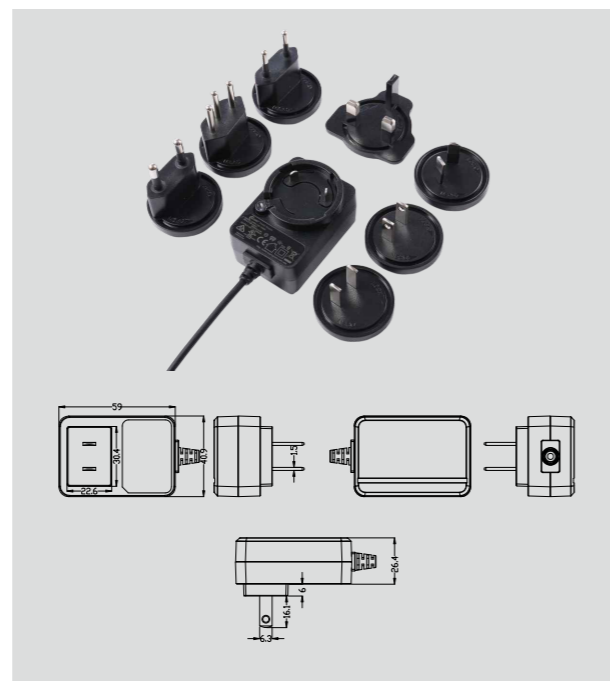

产品参数 / SPECIFICATIONS

输入电压 Input Voltage:100-240V
 输入频率 Input Frequency:50/60Hz
 输入电流 Input Current:0.8A
 输出电压 Out Voltage:5.0V-36.0V
 输出电流 Output Current:10mA-3000mA
 能效等级 Energy Class:VI
 工作温度 Operating Temperature:0-40°C
 储存温度 Storage Temperature:-20~80°C
 安规标准 Certification Standards:62368/61558/
 60335/ETL1310/CCC/CQC
 尺寸 Dimension:59*40.9*26.4MM
 重量 Weight:100g 质保 Warranty:2 years



产品参数 / SPECIFICATIONS

输入电压 Input Voltage:100-240V
 输入频率 Input Frequency:50/60Hz
 输入电流 Input Current:0.8A
 输出电压 Out Voltage:5.0V-36.0V
 输出电流 Output Current:10mA-3000mA
 能效等级 Energy Class:VI
 工作温度 Operating Temperature:0-40°C
 储存温度 Storage Temperature:-20~80°C
 安规标准 Certification Standards:62368/61558/
 ETL1310/CCC/CQC
 尺寸 Dimension:72.5*44.6*31.3MM
 重量 Weight:165g 质保 Warranty:2 years

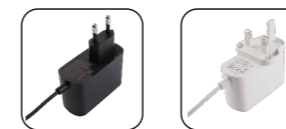

30W-20180

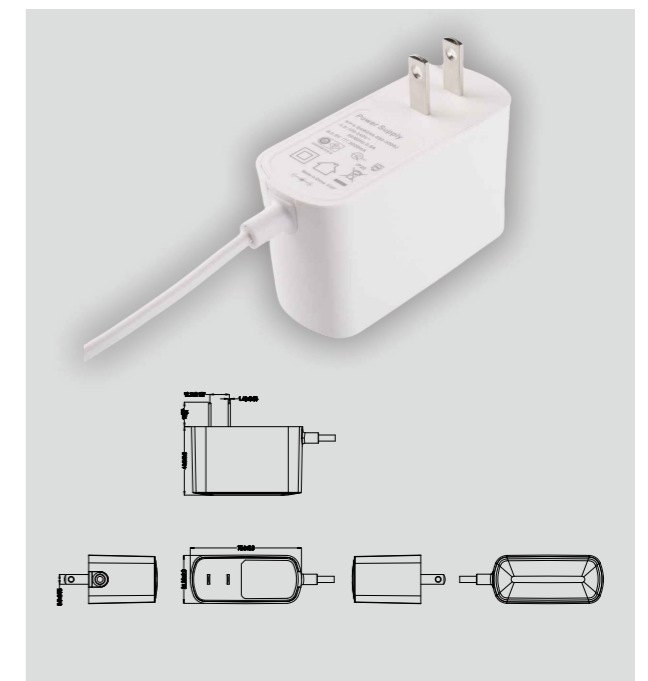

30W-19020



产品参数 / SPECIFICATIONS

输入电压 Input Voltage:100-240V
 输入频率 Input Frequency:50/60Hz
 输入电流 Input Current:0.8A
 输出电压 Out Voltage:5.0V-48.0V
 输出电流 Output Current:10mA-3500mA
 能效等级 Energy Class:VI
 工作温度 Operating Temperature:0-40°C
 储存温度 Storage Temperature:-20~80°C
 安规标准 Certification Standards:62368/61558/60335/
 UL1310/GB4706/GB4943
 尺寸 Dimension:91.9*45.4*27.5MM
 重量 Weight:166g 质保 Warranty:2 years



产品参数 / SPECIFICATIONS

输入电压 Input Voltage:100-240V
 输入频率 Input Frequency:50/60Hz
 输入电流 Input Current:0.8A
 输出电压 Out Voltage:5.0V-48.0V
 输出电流 Output Current:10mA-4000mA
 能效等级 Energy Class:VI
 工作温度 Operating Temperature:0-40°C
 储存温度 Storage Temperature:-20~80°C
 安规标准 Certification Standards:62368/GB4943
 尺寸 Dimension:91.9*45.4*30MM
 重量 Weight:166g 质保 Warranty:2 years



30W-22060

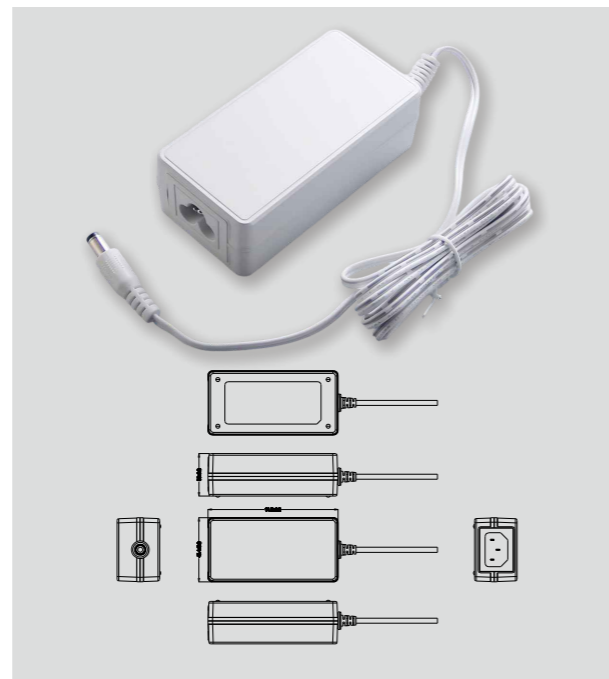

高尔夫球车
GOLF CART

30W-21070

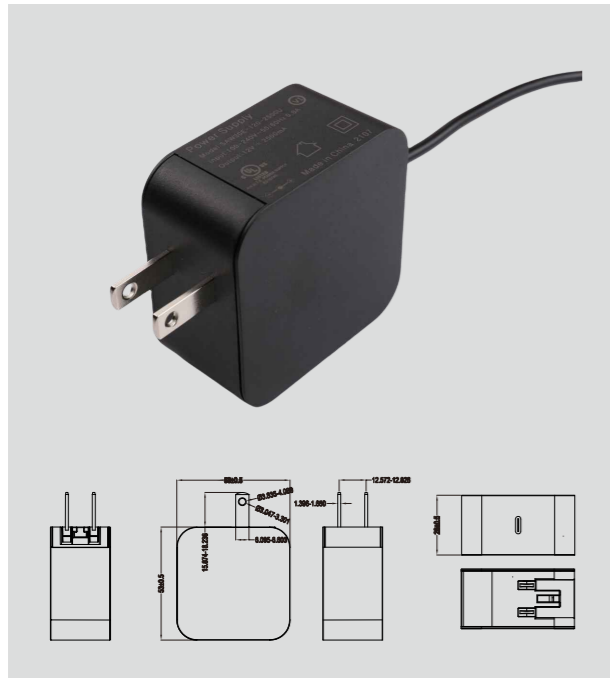

产品参数 / SPECIFICATIONS

输入电压 Input Voltage:100-240V
 输入频率 Input Frequency:50/60Hz
 输入电流 Input Current:0.8A Max
 输出电压 Out Voltage:5-30V
 输出电流 Output Current:10-3000mA
 能效等级 Energy Class:VI
 工作温度 Operating Temperature:0-40°C
 储存温度 Storage Temperature:-20~80°C
 安规标准 Certification Standards:62368/CCC
 尺寸 Dimension:53*53*28MM
 重量 Weight:180g 质保 Warranty:2 years



65W-21050

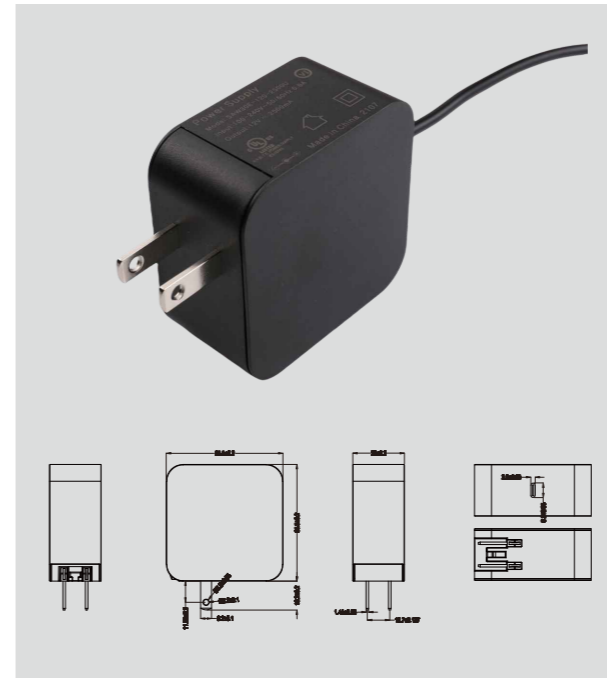

产品参数 / SPECIFICATIONS

输入电压 Input Voltage:100-240V
 输入频率 Input Frequency:50/60Hz
 输入电流 Input Current:1.3A Max
 输出电压 Out Voltage:5-30V
 输出电流 Output Current:10-5000mA
 能效等级 Energy Class:VI
 工作温度 Operating Temperature:0-40°C
 储存温度 Storage Temperature:-20~80°C
 安规标准 Certification Standards:62368/CCC
 尺寸 Dimension:65*65*29MM
 重量 Weight:250g 质保 Warranty:2 years



45W-21060

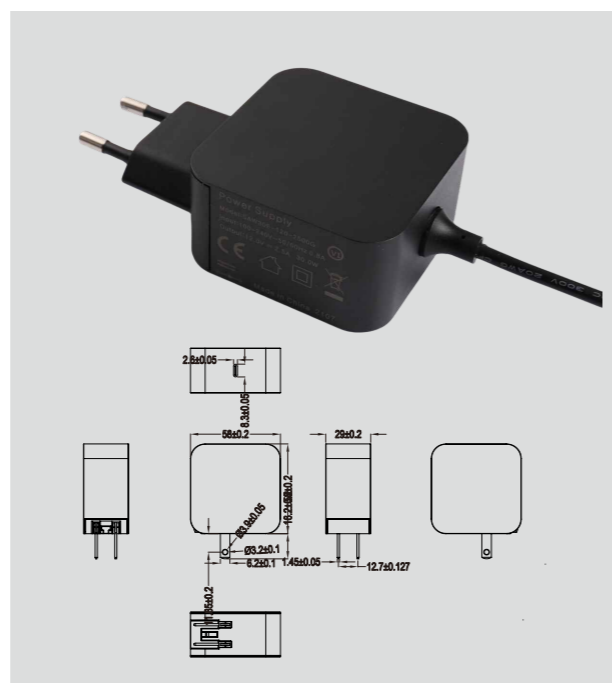

产品参数 / SPECIFICATIONS

输入电压 Input Voltage:100-240V
 输入频率 Input Frequency:50/60Hz
 输入电流 Input Current:1.3A Max
 输出电压 Out Voltage:5-30V
 输出电流 Output Current:10-3000mA
 能效等级 Energy Class:VI
 工作温度 Operating Temperature:0-40°C
 储存温度 Storage Temperature:-20~80°C
 安规标准 Certification Standards:62368/CCC
 尺寸 Dimension:58*58*29MM
 重量 Weight:250g 质保 Warranty:2 years



产品参数 / SPECIFICATIONS

输入电压 Input Voltage:100-240V
 输入频率 Input Frequency:50/60Hz
 输入电流 Input Current:1.3A Max
 输出电压 Out Voltage:5-48V
 输出电流 Output Current:10-6000mA
 能效等级 Energy Class:VI
 工作温度 Operating Temperature:0-40°C
 储存温度 Storage Temperature:-20~80°C
 安规标准 Certification Standards:62368/61558/
 60335/ETL1310/CCC/CQC
 尺寸 Dimension:90*47*31.97MM
 重量 Weight:220g 质保 Warranty:2 years



36W/48W-22100

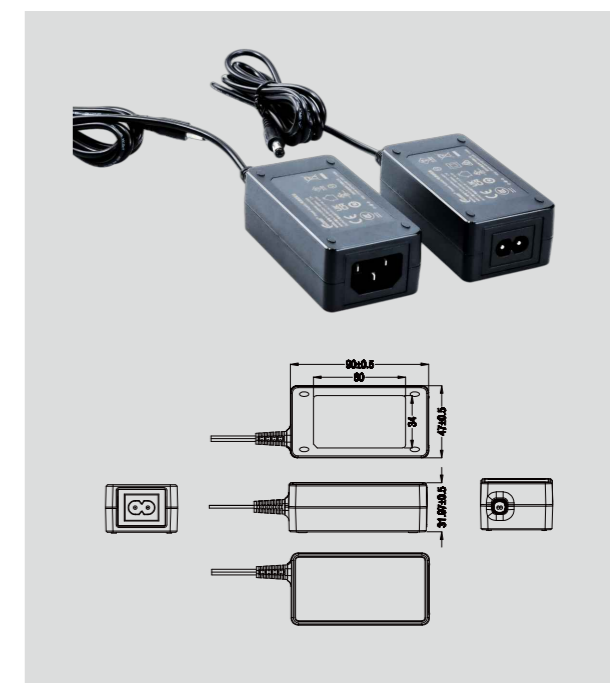

36W-20220

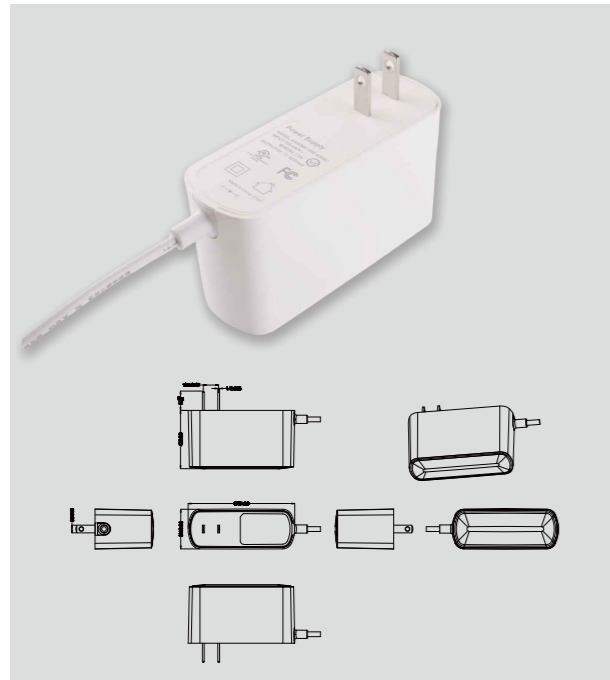

产品参数 / SPECIFICATIONS

输入电压 Input Voltage:100-240V
 输入频率 Input Frequency:50/60Hz
 输入电流 Input Current:1.3A Max
 输出电压 Out Voltage:5-48V
 输出电流 Output Current:10-6000mA
 能效等级 Energy Class:VI
 工作温度 Operating Temperature:0-40°C
 储存温度 Storage Temperature:-20~80°C
 安规标准 Certification Standards:62368/61558
 /ETL1310/CCC/CQC
 尺寸 Dimension:87.9*48.2*32.7MM
 重量 Weight:210g 质保 Warranty:2 years



65W-22210

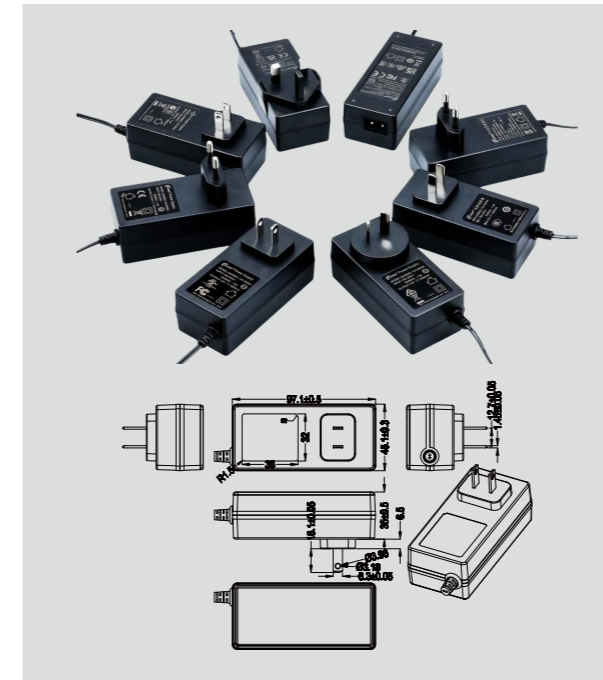

产品参数 / SPECIFICATIONS

输入电压 Input Voltage:100-240V
 输入频率 Input Frequency:50/60Hz
 输入电流 Input Current:1.5A Max
 输出电压 Out Voltage:5-48V
 输出电流 Output Current:10-6000mA
 能效等级 Energy Class:VI
 工作温度 Operating Temperature:0-40°C
 储存温度 Storage Temperature:-20~80°C
 安规标准 Certification Standards:62368/61558/
 60335/ETL1310/CCC/CQC
 尺寸 Dimension:97.1*45.1*35MM
 重量 Weight:230g 质保 Warranty:2 years



产品参数 / SPECIFICATIONS

输入电压 Input Voltage:100-240V
 输入频率 Input Frequency:50/60Hz
 输入电流 Input Current:1.3A Max
 输出电压 Out Voltage:5-48V
 输出电流 Output Current:10-6000mA
 能效等级 Energy Class:VI
 工作温度 Operating Temperature:0-40°C
 储存温度 Storage Temperature:-20~80°C
 安规标准 Certification Standards:62368/61558
 /ETL1310/CCC/CQC
 尺寸 Dimension:96.51*48*31MM
 重量 Weight:220g 质保 Warranty:2 years



48W-23130

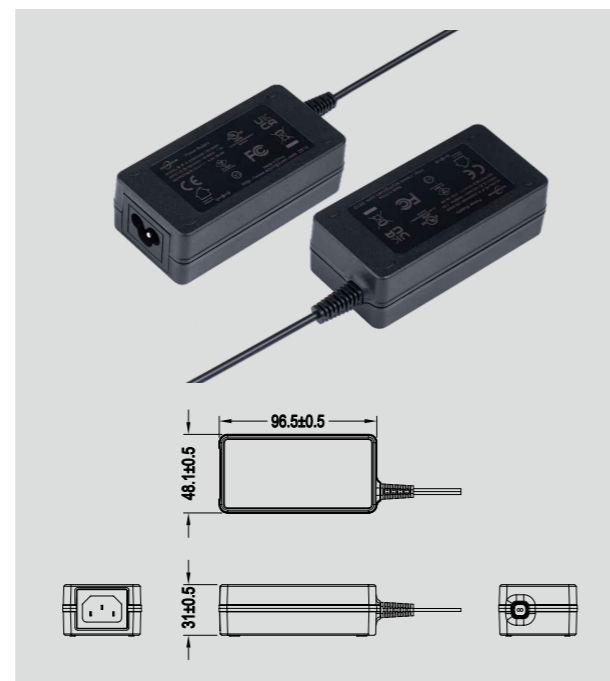

产品参数 / SPECIFICATIONS

输入电压 Input Voltage:100-240V
 输入频率 Input Frequency:50/60Hz
 输入电流 Input Current:1.5A Max
 输出电压 Out Voltage:5-48V
 输出电流 Output Current:10-7500mA
 能效等级 Energy Class:VI
 工作温度 Operating Temperature:0-40°C
 储存温度 Storage Temperature:-20~80°C
 安规标准 Certification Standards:62368/61558/CQC
 尺寸 Dimension:135.4*54.9*35MM
 重量 Weight:376g 质保 Warranty:2 years



96W-19280

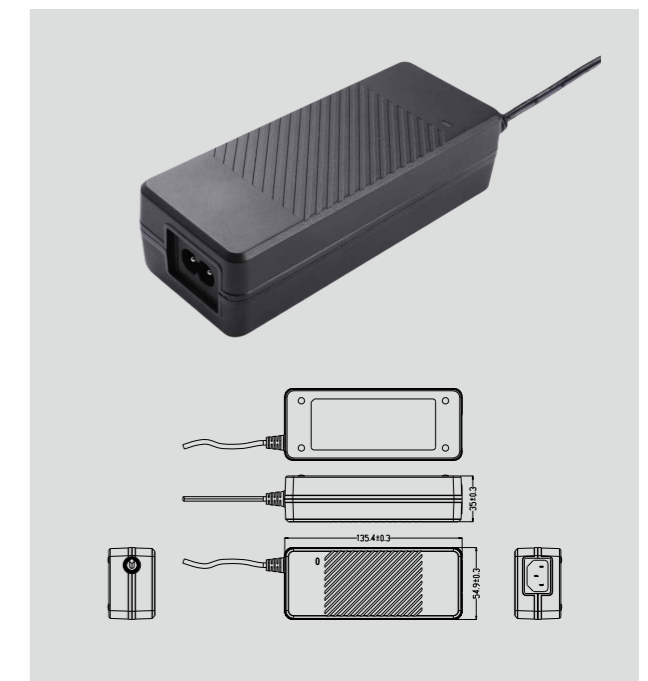

120W-22220



产品参数 / SPECIFICATIONS

输入电压 Input Voltage: 100-240V
 输入频率 Input Frequency: 50/60Hz
 输入电流 Input Current: 2.0A Max
 输出电压 Out Voltage: 5-48V
 输出电流 Output Current: 10-10000mA
 能效等级 Energy Class: VI
 工作温度 Operating Temperature: 0-40°C
 储存温度 Storage Temperature: -20~80°C
 安规标准 Certification Standards: 62368/CCC
 尺寸 Dimension: 142.4*62*31.8MM
 重量 Weight: 420g 质保 Warranty: 2 years



120W-25100

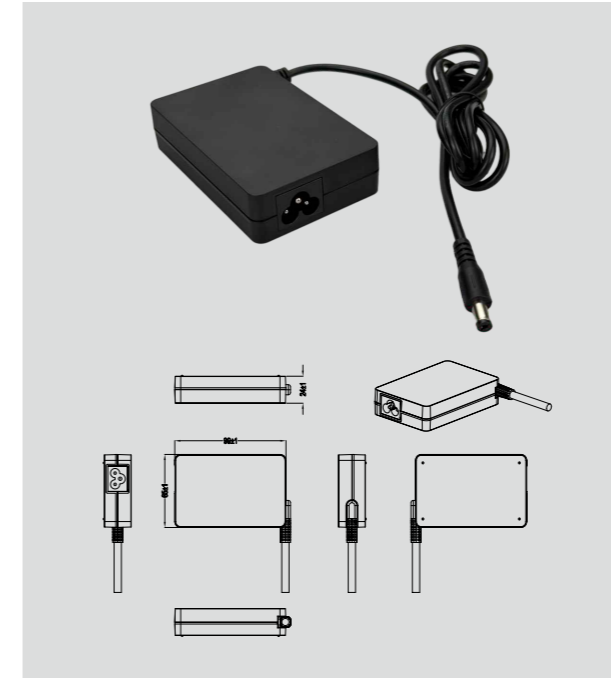

产品参数 / SPECIFICATIONS

输入电压 Input Voltage: 100-240V
 输入频率 Input Frequency: 50/60Hz
 输入电流 Input Current: 2.0A Max
 输出电压 Out Voltage: 5-36V
 输出电流 Output Current: 10-6667mA
 能效等级 Energy Class: VI
 工作温度 Operating Temperature: 0-25°C
 储存温度 Storage Temperature: -20~80°C
 安规标准 Certification Standards: 62368/CCC
 尺寸 Dimension: 99*65*24MM
 重量 Weight: 240g 质保 Warranty: 2 years



150W/180W-20340

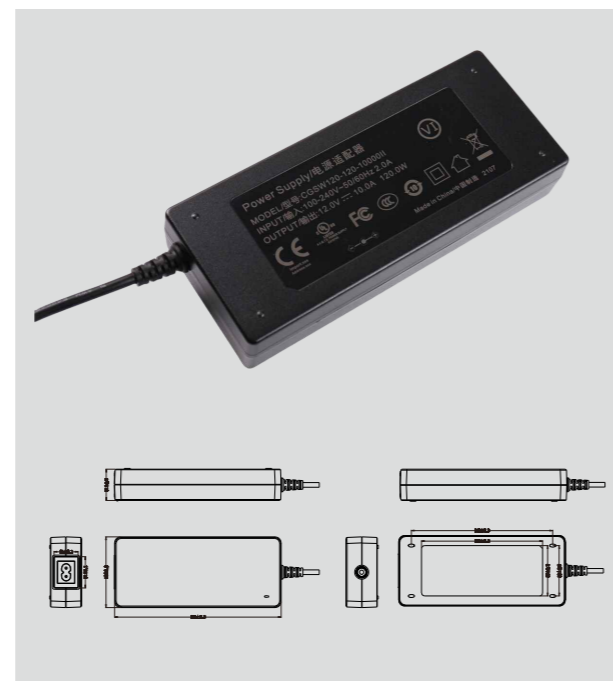

产品参数 / SPECIFICATIONS

输入电压 Input Voltage: 100-240V
 输入频率 Input Frequency: 50/60Hz
 输入电流 Input Current: 2.5A Max
 输出电压 Out Voltage: 12-48V
 输出电流 Output Current: 10-12500mA
 能效等级 Energy Class: VI
 工作温度 Operating Temperature: 0-40°C
 储存温度 Storage Temperature: -20~80°C
 安规标准 Certification Standards: 62368/61558/CCC
 尺寸 Dimension: 165*70*31MM
 重量 Weight: 420g 质保 Warranty: 2 years

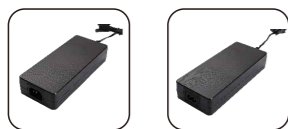

产品参数 / SPECIFICATIONS

额定输入电压 Rated input voltage	100Vac-240Vac
输入频率 Input Frequency	50/60 Hz
输入电流 Input current	2.5A MAX
功率因数 Power Factor	≥0.9 Input 230Vac@ Full load
输出电压 Output Voltage	10-88.2V
输出电流 Output Current	0.1-10A
满载效率 Full Load Efficiency	≥90% Input 230Vac@ Full load
工作温度 Operating Temperature	-10°C~40°C
储存温度 Storage Temperature	-40°C~70°C
产品尺寸 Dimensions(mm)	145.8*64.8*31
产品净重 Net Weight	0.5KG

规格型号 Model	铁锂/LiFePO4	14.6V10A	29.2V6A	43.8V4A	58.4V3A	73V2.4A	87.6V2A
	三元/lithium battery	12.6V10A	29.4V6A	42V4A	54.6V3A	71.4V2.5A	84V2A
	铅酸/Lead-acid	12V10A	24V6A	36V4A	48V3A	60V2.5A	72V2A

180W 电池充电器



240W 电池充电器

Appearance Size / 外观尺寸

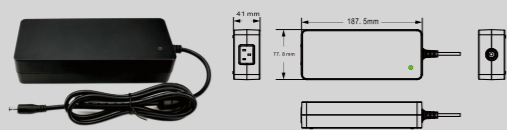

Optional Connectors 可选连接线



产品参数 / SPECIFICATIONS

额定输入电压 Rated input voltage	100Vac-240Vac
输入频率 Input Frequency	50/60 Hz
输入电流 Input current	5A MAX
功率因数 Power Factor	≥0.9 Input 230Vac@ Full load
输出电压 Output Voltage	10-88.2V
输出电流 Output Current	0.1-12A
满载效率 Full Load Efficiency	≥90% Input 230Vac@ Full load
工作温度 Operating Temperature	-10°C~40°C
储存温度 Storage Temperature	-40°C~70°C
产品尺寸 Dimensions(mm)	187.5*77.8*41
产品净重 Net Weight	1.1KG

规格型号 Model	铁锂/LiFePO4	14.6V10A	29.2V8A	43.8V5A	58.4V4A	73V3A	87.6V2.5A
	三元/lithium battery	12.6V10A	29.4V8A	42V5A	54.6V4A	71.4V3A	84V2.5A
	铅酸/Lead-acid	12V10A	24V8A	36V5A	48V4A	60V3A	72V2.5A

300W 电池充电器

产品参数 / SPECIFICATIONS

额定输入电压 Rated input voltage	100Vac-240Vac
输入频率 Input Frequency	50/60 Hz
输入电流 Input current	5A MAX
功率因数 Power Factor	≥0.9 Input 230Vac@ Full load
输出电压 Output Voltage	10-90V
输出电流 Output Current	0.1-20A
满载效率 Full Load Efficiency	≥88% Input 230Vac@ Full load
工作温度 Operating Temperature	-10°C~40°C
储存温度 Storage Temperature	-40°C~70°C
产品尺寸 Dimensions(mm)	205.4*93.9*41
产品净重 Net Weight	1.2KG

Appearance Size / 外观尺寸

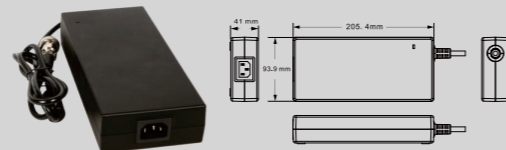

Optional Connectors 可选连接线



规格型号 Model	铁锂/LiFePO4	14.6V18A	29.2V10A	43.8V7A	58.4V5A	73V4A	87.6V3A
	三元/lithium battery	12.6V18A	29.4V10A	42V7A	54.6V5A	71.4V4A	84V3A
	铅酸/Lead-acid	12V18A	24V10A	36V7A	48V5A	60V4A	72V3A



美容仪/
脱毛仪/医疗设备
BEAUTY INSTRUMENT
HAIR REMOVAL DEVICE
MEDICAL EQUIPMENT

36W-23050



产品参数 / SPECIFICATIONS

输入电压 Input Voltage: 100-240V
 输入频率 Input Frequency: 50/60Hz
 输入电流 Input Current: 1.3A Max
 输出电压 Out Voltage: 12-24V
 输出电流 Output Current: 10-3000mA
 能效等级 Energy Class: VI
 工作温度 Operating Temperature: 0-40°C
 储存温度 Storage Temperature: -20~80°C
 安规标准 Certification Standards: GB4706.1
 尺寸 Dimension: 63*63*30.7MM
 重量 Weight: 250g 质保 Warranty: 2 years



65W 医疗-24030 / 68W 医疗-24060 / 96W 医疗-24040

产品参数 / SPECIFICATIONS

输入电压 Input Voltage: 200-240V
 输入频率 Input Frequency: 50/60Hz
 输入电流 Input Current: 1.5-0.9A Max
 输出电压 Out Voltage: 5-48V
 输出电流 Output Current: 100-6000mA
 能效等级 Energy Class: VI
 工作温度 Operating Temperature: 0-40°C
 储存温度 Storage Temperature: -20~80°C
 安规标准 Certification Standards: GB4706.1
 尺寸 Dimension: 84*59*32MM
 重量 Weight: 150g 质保 Warranty: 2 years

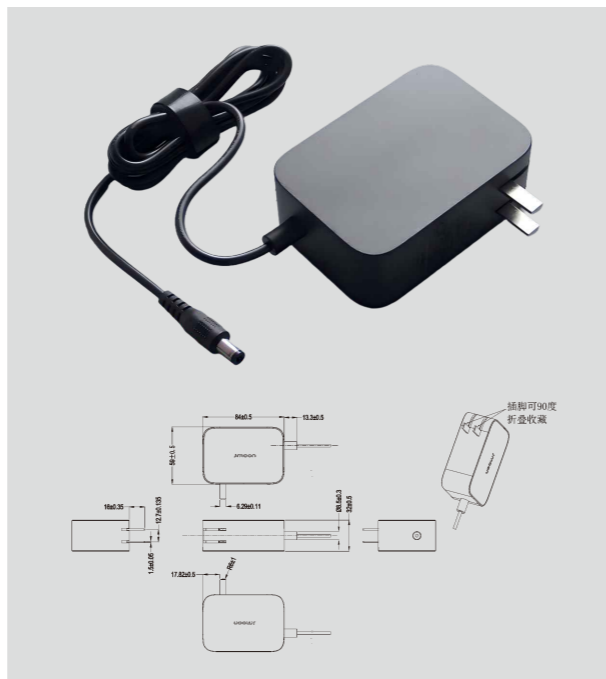

清洁设备

CLEANING EQUIPMENT



18W-24210

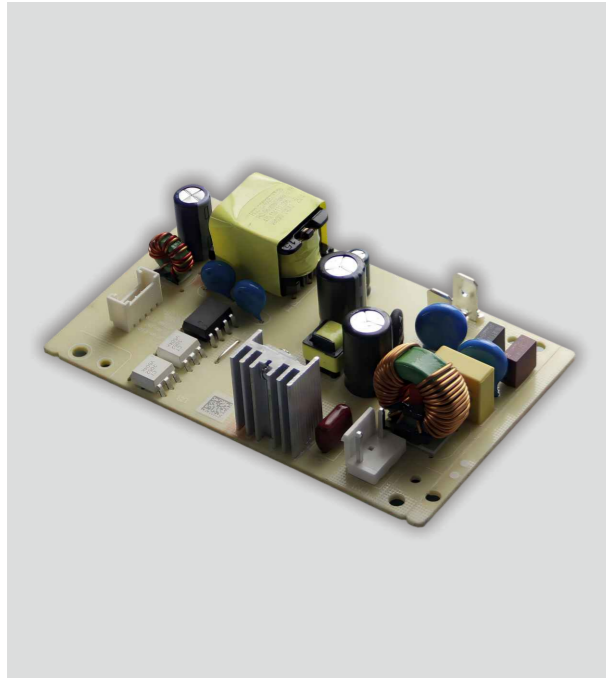

产品参数 / SPECIFICATIONS

输入电压 Input Voltage:100-240V
 输入频率 Input Frequency:50/60Hz
 输入电流 Input Current:0.3A Max
 输出电压 Out Voltage:19-36V
 输出电流 Output Current:500-950mA
 工作温度 Operating Temperature:0-40°C
 储存温度 Storage Temperature:-20~80°C
 尺寸 Dimension:90*60*22MM
 重量 Weight:75g 质保 Warranty:2 years

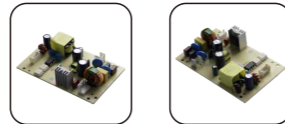

40W-24190



产品参数 / SPECIFICATIONS

输入电压 Input Voltage:100-240V
 输入频率 Input Frequency:50/60Hz
 输入电流 Input Current:0.7A Max
 输出电压 Out Voltage:19-36V
 输出电流 Output Current:1100-2100mA
 工作温度 Operating Temperature:0-40°C
 储存温度 Storage Temperature:-20~80°C
 尺寸 Dimension:120*75*23MM
 重量 Weight:140g 质保 Warranty:2 years

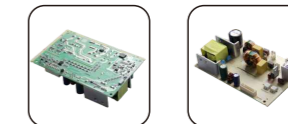

产品参数 / SPECIFICATIONS

输入电压 Input Voltage:100-240V
 输入频率 Input Frequency:50/60Hz
 输入电流 Input Current:0.4A Max
 输出电压 Out Voltage:19-36V
 输出电流 Output Current:700-1300mA
 工作温度 Operating Temperature:0-40°C
 储存温度 Storage Temperature:-20~80°C
 尺寸 Dimension:90*60*22MM
 重量 Weight:50g 质保 Warranty:2 years

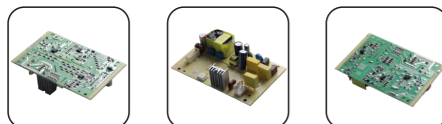

25W-24170

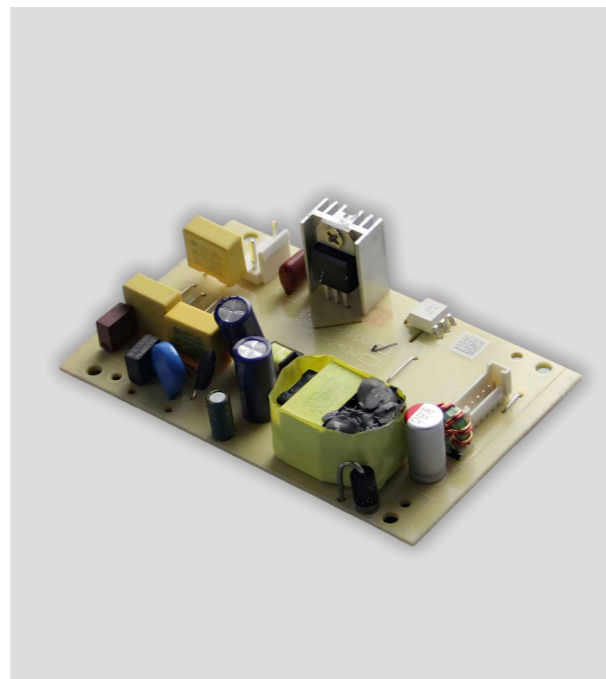

产品参数 / SPECIFICATIONS

输入电压 Input Voltage:100-240V
 输入频率 Input Frequency:50/60Hz
 输入电流 Input Current:1.2A Max
 输出电压 Out Voltage:19-36V
 输出电流 Output Current:1950-3700mA
 工作温度 Operating Temperature:0-40°C
 储存温度 Storage Temperature:-20~80°C
 尺寸 Dimension:142*70*23MM
 重量 Weight:220g 质保 Warranty:2 years

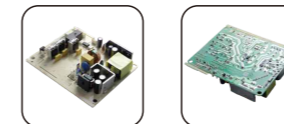

70W-25080

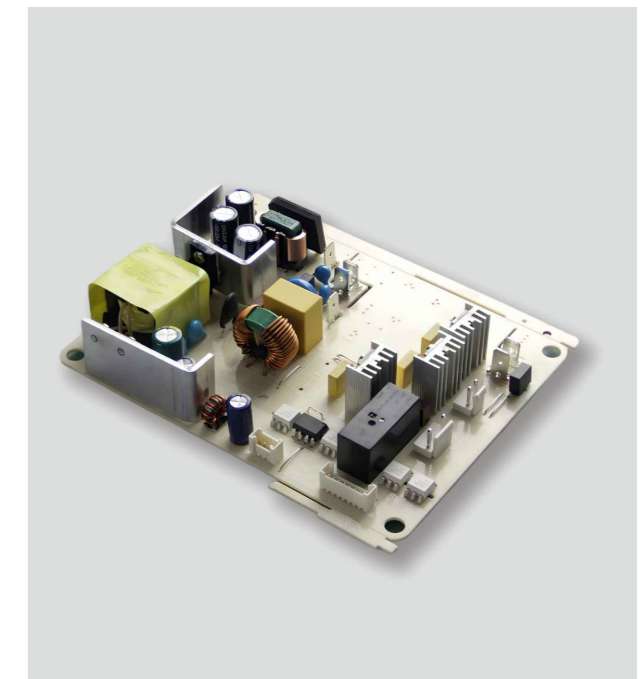

225W裸板电源

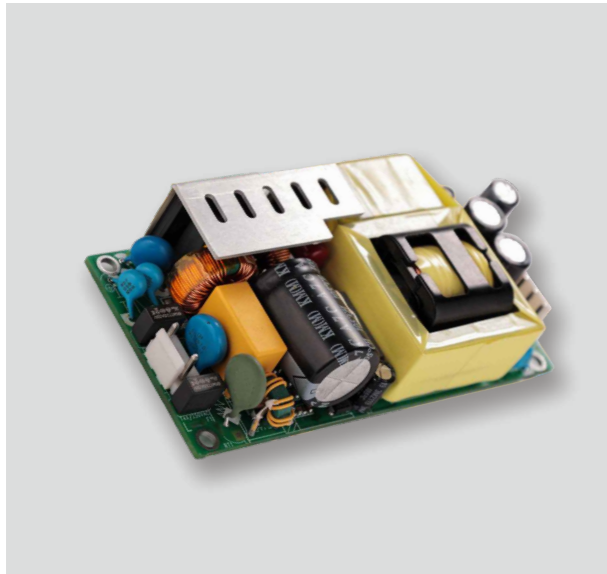

产品参数 / SPECIFICATIONS

额定输入电压 Rated input voltage:100Vac-240Vac
 输入频率 Input Frequency:47-63 Hz
 输入电流 Input current:3A MAX
 功率因数 Power Factor:≥0.9 Input230Vac@Full load
 输出电压 Output Voltage:12V-48V
 输出电流 Output Curren:0.1-12A
 满载效率 Full Load Efficiency:≥92%Input230Vac@Full load
 工作温度 Operating Temperature:-10°C~40°C
 储存温度 Storage Temperature:-40°C~70°C
 尺寸 Dimension:101.6*52.5*27.5MM
 重量 Weight:200g 质保 Warrenty:2 years

规格型号 Model	输出电压 output voltage	12V	15V	18V	24V	48V	自然散热 Natural heat dissipation 13CFM 风冷 13CFM air-cooled
	额定电流 Rated current	11.67A	9.33A	7.77A	5.83A	2.91A	
		18.75A	15A	12.5A	9.4A	4.7A	

240W裸板电源

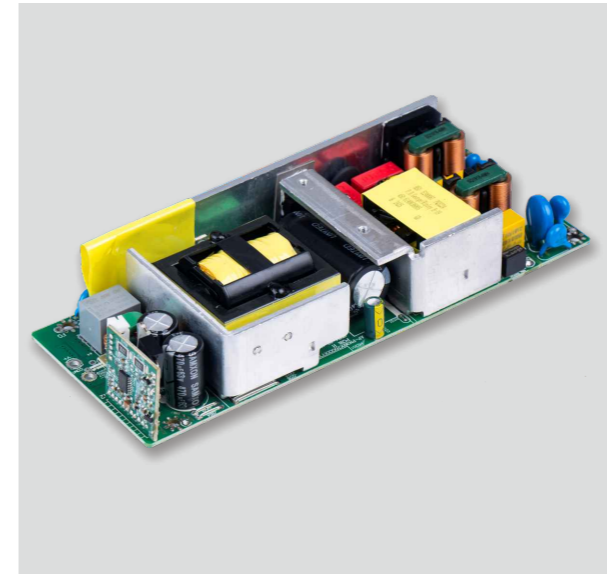

产品参数 / SPECIFICATIONS

额定输入电压 Rated input voltage:100Vac-240Vac
 输入频率 Input Frequency:50/60Hz
 输入电流 Input current:5A MAX
 功率因数 Power Factor:≥0.9 Input230Vac@Full load
 输出电压 Output Voltage:10-88.2V
 输出电流 Output Curren:0.1-12A
 满载效率 Full Load Efficiency:≥92% Input 230Vac@Full load
 工作温度 Operating Temperature:-10°C~40°C
 储存温度 Storage Temperature:-40°C~70°C
 尺寸 Dimension:174*66.7*31.88MM
 重量 Weight:0.41kg 质保 Warrenty:2 years

规格型号 Model	铁锂/LiFePO4	14.6V12A	29.2V8A	43.8V5A	58.4V4A	73V3A	87.6V2.5A
	三元/lithium battery	12.6V12A	29.4V8A	42V5A	54.6V4A	71.4V3A	84V2.5A
	铅酸/Lead-acid	12V12A	24V8A	36V5A	48V4A	60V3A	72V2.5A

550W裸板电源

产品参数 / SPECIFICATIONS

额定输入电压 Rated input voltage:100Vac-240Vac
 输入频率 Input Frequency:47-63 Hz
 输入电流 Input current:5A MAX
 功率因数 Power Factor:≥0.95Input230Vac@Full load
 输出电压 Output Voltage:12V-72V
 输出电流 Output Curren:0.1-25A
 满载效率 Full Load Efficiency:≥92% Input230Vac@Full load
 工作温度 Operating Temperature:-10°C~40°C
 储存温度 Storage Temperature:-40°C~70°C
 尺寸 Dimension:127*76*38MM
 重量 Weight:400g 质保 Warrenty:2 years

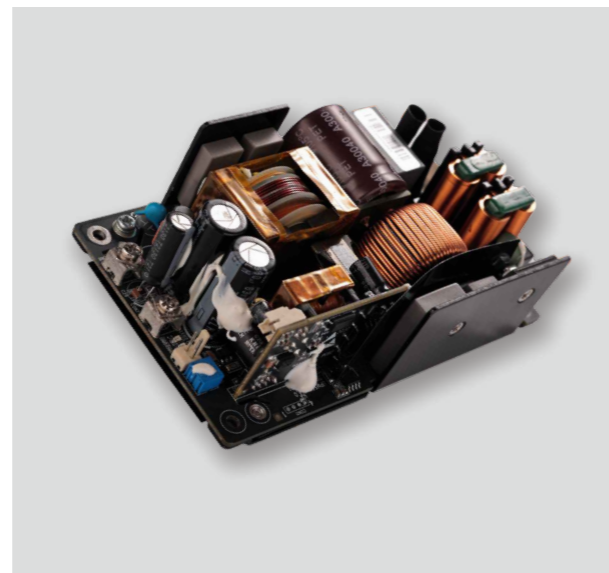

规格型号 Model	输出电压 output voltage	12V	24V	36V	48V	54V	72V	自然散热 Natural heat dissipation 13CFM 风冷 13CFM air-cooled
	额定电流 Rated current	25A	12.5A	8.34A	6.25A	5.56A	4.17A	
		37.5A	22.92A	15.28A	11.46A	10.19A	7.64A	

产品参数 / SPECIFICATIONS

额定输入电压 Rated input voltage:100Vac-240Vac
 输入频率 Input Frequency:50/60Hz
 输入电流 Input current:8A MAX
 功率因数 Power Factor:≥0.95 Input230Vac@Full load
 输出电压 Output Voltage:10-88.2V
 输出电流 Output Curren:0.1-30A
 满载效率 Full Load Efficiency:≥92% Input 230Vac@Full load
 工作温度 Operating Temperature:-10°C~40°C
 储存温度 Storage Temperature:-40°C~70°C
 尺寸 Dimension:188.9*87.5*42.5MM
 重量 Weight:0.59kg 质保 Warrenty:2 years

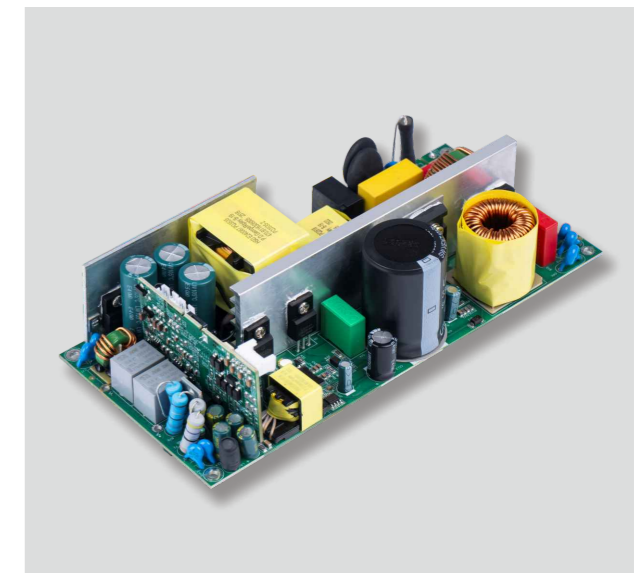

规格型号 Model	铁锂/LiFePO4	14.6V30A	29.2V20A	43.8V13A	58.4V10A	73V8A	87.6V7A
	三元/lithium battery	12.6V30A	29.4V20A	42V14A	54.6V10A	71.4V8A	84V7A
	铅酸/Lead-acid	12V30A	24V20A	36V14A	48V10A	60V8A	72V7A



900W裸板电源

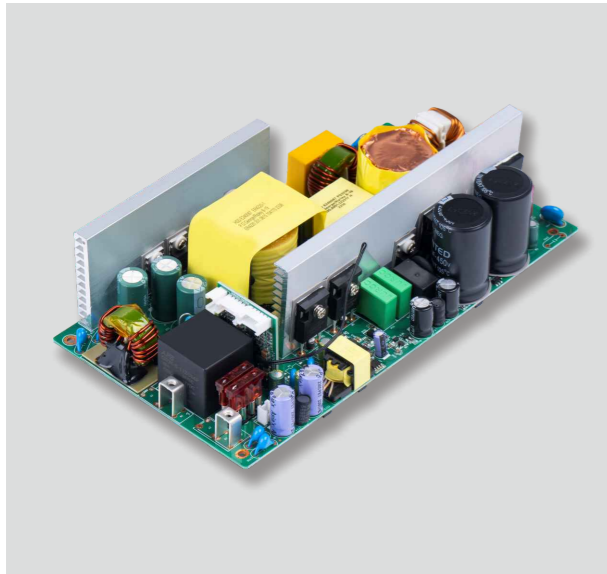

产品参数 / SPECIFICATIONS

额定输入电压 Rated input voltage:100Vac-240Vac
 输入频率 Input Frequency:50/60Hz
 输入电流 Input current:12A MAX
 功率因数 Power Factor:≥0.95 Input230Vac@Full load
 输出电压 Output Voltage:10-88V
 输出电流 Output Curren:0.1-55A
 满载效率 Full Load Efficiency:≥92% Input 230Vac@Full load
 工作温度 Operating Temperature:-10°C~40°C
 储存温度 Storage Temperature:-40°C~70°C
 尺寸 Dimension:213*115.8*55.2MM
 重量 Weight:1.01kg 质保 Warrenty:2 years

规格型号 Model	铁锂/LiFePO4	14.6V55A	29.2V30A	43.8V20A	58.4V15A	73V12A	87.6V10A
	三元/lithium battery	12.6V55A	29.4V30A	42V20A	54.6V15A	71.4V12A	84V10A
	铅酸/Lead-acid	12V55A	24V30A	36V20A	48V15A	60V12A	72V10A

1200W裸板电源

产品参数 / SPECIFICATIONS

额定输入电压 Rated input voltage:100Vac-240Vac
 输入频率 Input Frequency:50/60Hz
 输入电流 Input current:16A MAX
 功率因数 Power Factor:≥0.95 Input230Vac@Full load
 输出电压 Output Voltage:12-90V
 输出电流 Output Curren:0.1-70A
 满载效率 Full Load Efficiency:≥92% Input 230Vac@Full load
 工作温度 Operating Temperature:-10°C~40°C
 储存温度 Storage Temperature:-40°C~70°C
 尺寸 Dimension:215*120*74MM
 重量 Weight:1.66kg 质保 Warrenty:2 years

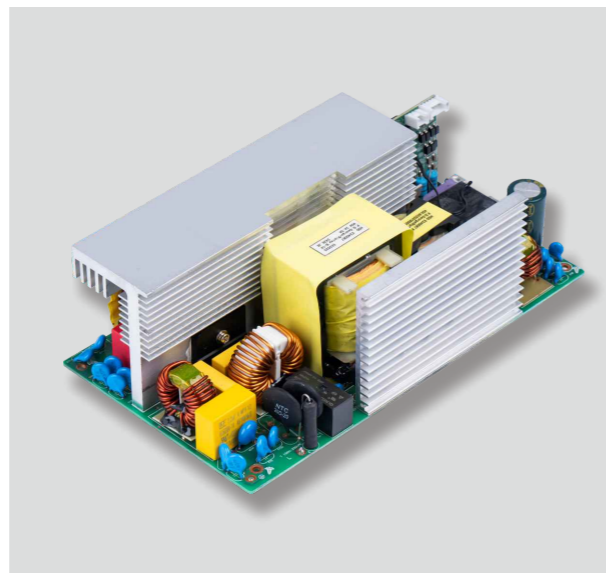

规格型号 Model	铁锂/LiFePO4	14.6V70A	29.2V40A	43.8V27A	58.4V20A	73V16A	87.6V14A
	三元/lithium battery	12.6V70A	29.4V40A	42V27A	54.6V20A	71.4V16A	84V14A
	铅酸/Lead-acid	12V70A	24V40A	36V27A	48V20A	60V16A	72V14A

Input plug 输入插头



Output plug 输出连接器

